

# 設計/開発プロセスへのOpenFOAM展開

## ～CADモデルからの計算フロー構築の試み

---

2010.8.21 第3回勉強会

一 沢 潤

# 1. やりたいこと(環境構築)

## ・現状: 商用ソフト, Star-CD, -CCM+ による設計, 開発支援

⇒ 商用であるがための制約(ライセンス数・形態、機能、ベンダポリシー ...)

⇒ やるべきことがやるべき時にできない

開発プロセスがソフト(ベンダ)に依存する



## ・設計/開発プロセスへのOpenFOAM展開

⇒ だれでも・いつでもCFD(CAE)にアクセスできる環境

やるべきことがやるべき時にできる環境

・CADデータ活用

・格子生成/ポスト処理は汎用Mesher活用?

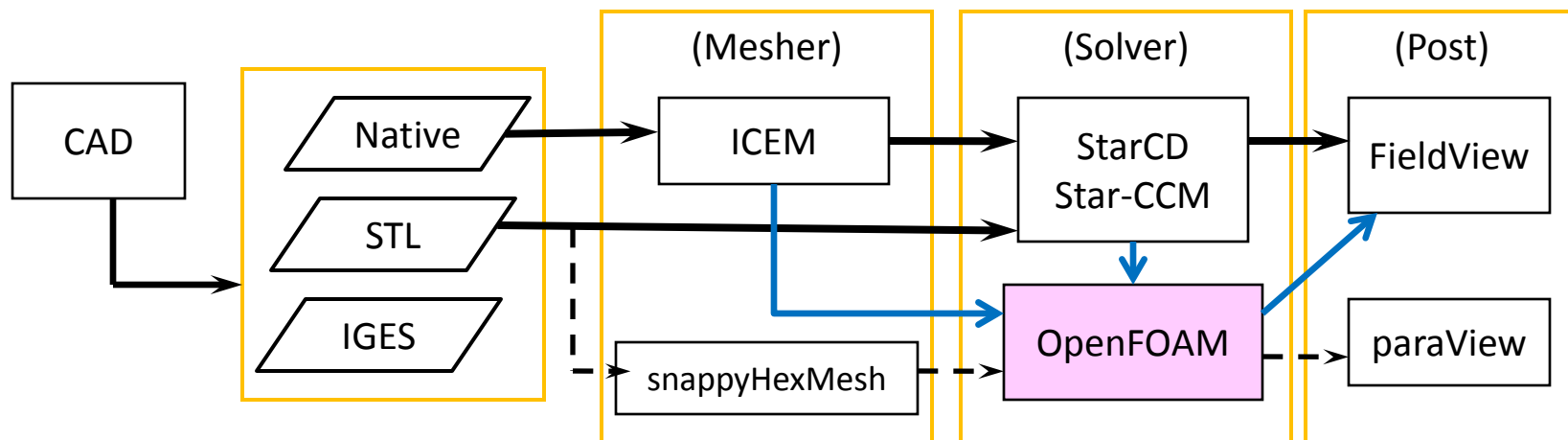

## 2. やりたいこと(対象と課題)

---

### 評価項目:

- ・圧力損失, 風量配分, 温度分布

### 要検討項目:

- ・複雑形状(CADデータ活用)
- ・熱交換器: Porous,  
熱エネルギーソース付与方法

### 3. やったこと

#### ■ OpenFOAMのDown Load, Install ( 2009.11 ~ )

DEXCS, OpenFOAM 1.6

#### ■ Tutorial: icoFoam, simpleFoam, . . . .

#### ■ Trial on Practical Configurations

- STL -> snappyHexMesh -> simpleFoam -> paraView
- ICEM -> proStar -> (starToFOAM) -> simpleFoam  
-> (foamToFieldview9) -> Fieldview

#### ■ Temperature Calculation

- proStar -> (starToFOAM) -> buoyantBoussinesqFoam  
-> (foamToFieldview9) -> Fieldview

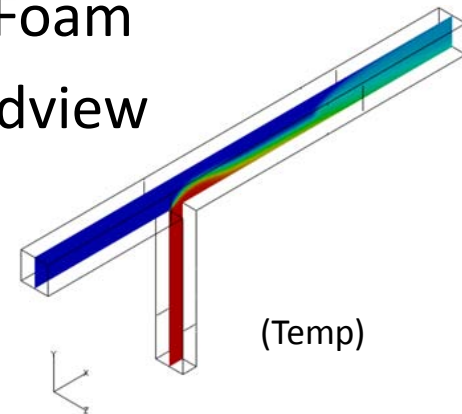

## 4. 本日の紹介内容

---

事例1 : CADデータから格子生成し、FOAMで計算し評価するには  
どうすればよいか？

- ・CAD⇒STL⇒blockMesh⇒snappyHexMesh⇒FOAM⇒Fieldview
- ・CAD⇒(Star-CD)⇒ICEM⇒FOAM⇒Fieldview
- ・結果のStar-CDとの比較
- ・困りごと

事例2 : 温度の計算はどうすればできるか？

- ・ buoyantBoussinesqSimpleFoam
- ・困りごと

事例3 : Porousを含む流れ場の計算はどうすればできるか？

- ・ rhoPorousSimpleFoam
- ・困りごと

# 事例1: (1)CAD⇒STL⇒blockMesh ⇒ snappyHexMesh

## - DEXCS利用

CAD⇒(Prostar)⇒STL

- 境界条件付与面毎に別Data(File)として作成

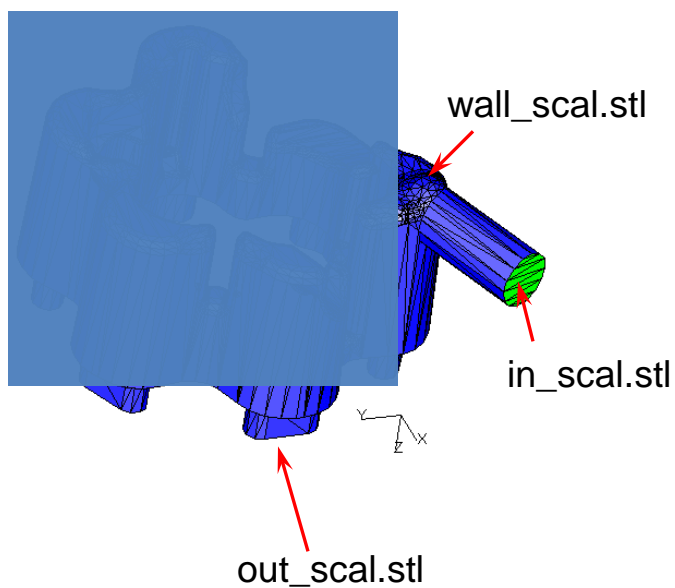

( Model detail masked. Sorry! )

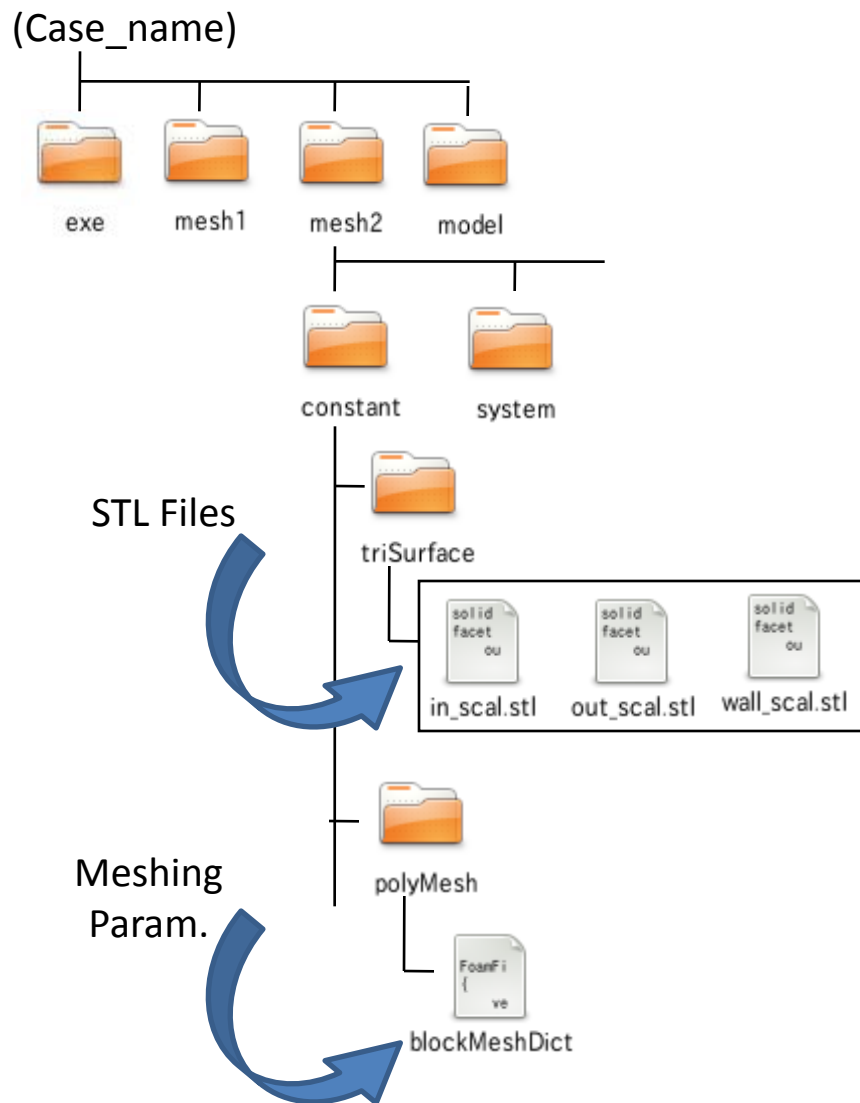

# 事例 1 : (1)CAD⇒STL⇒blockMesh ⇒ snappyHexMesh

## blockMeshDict

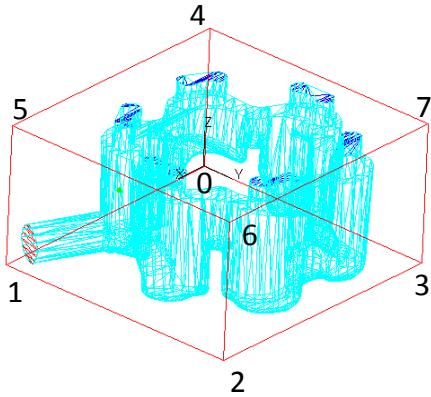

```
FoamFile
{
  version    2.0;
  format     ascii;
  class      dictionary;
  object     blockMeshDict;
}

convertToMeters 1;

vertices
(
  (-0.050 -0.057 -0.044) // 0
  ( 0.057 -0.057 -0.044) // 1
  ( 0.057  0.046 -0.044) // 2
  (-0.050  0.046 -0.044) // 3
  (-0.050 -0.057  0.011) // 4
  ( 0.057 -0.057  0.011) // 5
  ( 0.057  0.046  0.011) // 6
  (-0.050  0.046  0.011) // 7
);

blocks
(
  hex (0 1 2 3 4 5 6 7) (20 20 10) simpleGrading (1 1 1)
);

edges ();
patches ();
mergePatchPairs ();
```

⇒ blockMesh, snappyHexMesh

# 事例 1 : (1)CAD⇒STL⇒blockMesh ⇒ snappyHexMesh

## Mesh by snappyHexMesh

( Partial Zoomed Mesh )

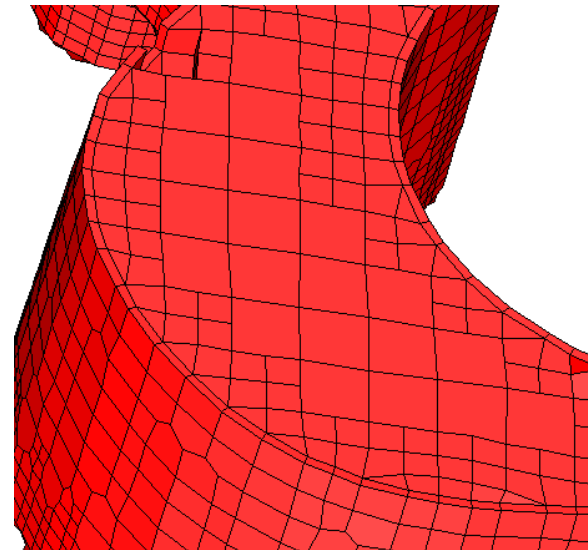
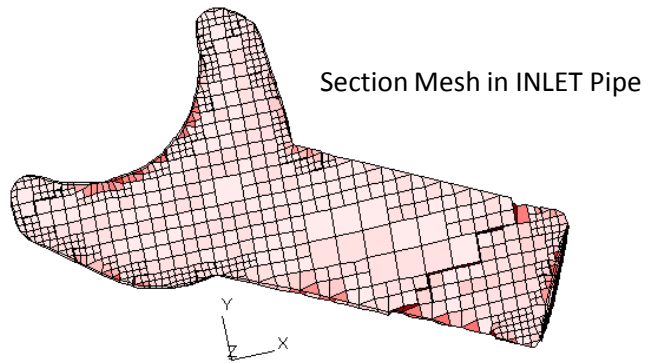

# 事例 1 : (1)CAD⇒STL⇒blockMesh ⇒ snappyHexMesh

## Boundary - Position

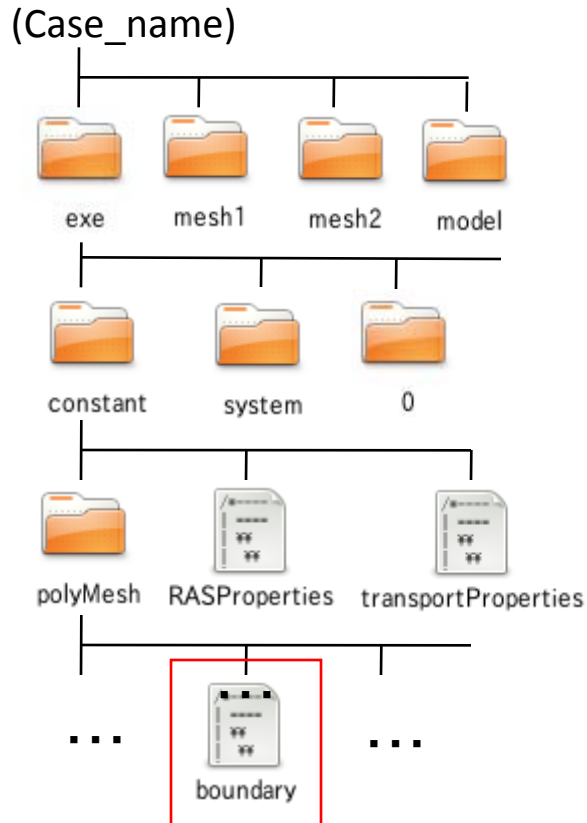

```
defaultFaces
{
    type        empty;
    nFaces      0;
    startFace   364536;
}
out_scal_ascii
{
    type        patch;
    nFaces      1553;
    startFace   364536;
}
in_scal_ascii
{
    type        patch;
    nFaces      245;
    startFace   366089;
}
wall_scal_ascii
{
    type        wall;
    nFaces      34901;
    startFace   366334;
}
```

# 事例 1 : (1)CAD⇒STL⇒blockMesh ⇒ snappyHexMesh

## Boundary - Value

( U.prepotential )

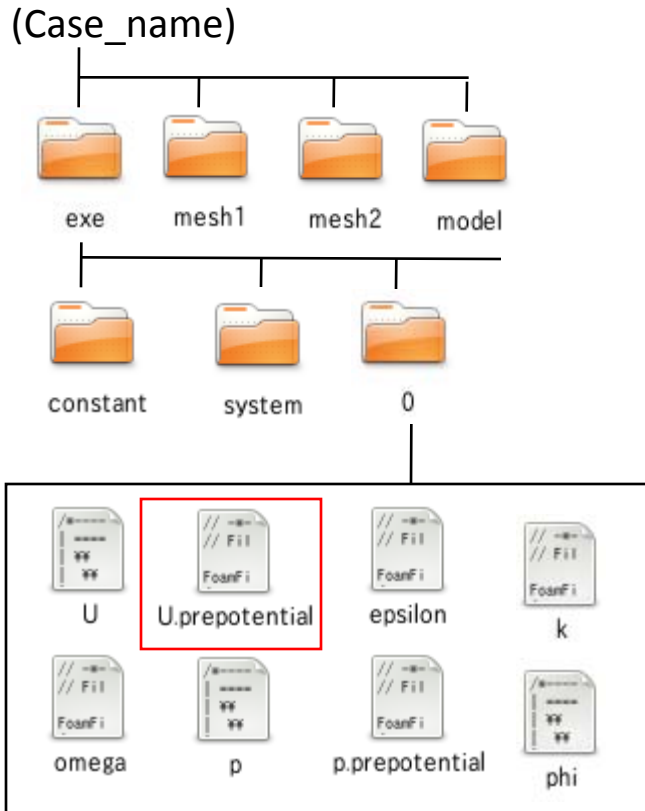

```
dimensions [ 0 1 -1 0 0 0 0 ];
```

```
internalField uniform (0 0 0);
```

```
boundaryField
```

```
{  
  in_scal_ascii  
  {  
    type fixedValue;  
    value uniform ( -0.910 0.4147 0.0 );  
  }  
  defaultFaces  
  {  
    type empty;  
  }  
  out_scal_ascii  
  {  
    type zeroGradient;  
  }  
  wall_scal_ascii  
  {  
    type fixedValue;  
    value uniform ( 0. 0. 0. );  
  }  
}
```

# 事例 1 : (2)Calculation Results - simpleFoam

---

On Fieldview (data conversion : [foamToFieldview9](#) )

Surf. Press.

Data are not shown . Sorry!!

Sect. Velocity Vect.

Data are not shown . Sorry!!

# 事例 1 : (2) Calculation Results - Comparison with Star-CD Results

- Mesh by snappyhexMesh
- Foam to Star Mesh Data Conversion : [foamToStarMesh](#) ( only to Star V4 )

Surf. Press.

simpleFoam  
(non-dimensional Press)

Star-CD  
( Pa at dens=1.205kg/m<sup>3</sup>, MARS\*)

Star-CD  
( Pa at dens=1.205kg/m<sup>3</sup>, UD)

Data are not shown . Sorry!!

- : Monotone Advection and Reconstruction Scheme,  
gradient-based second order accurate differencing scheme

# 事例 1 : (2) Calculation Results - Comparison with Star-CD Results

## Flow Rate per Outlet

The model have 1-inlet and 6-outlets.

The detail of the model are not shown. Sorry!!

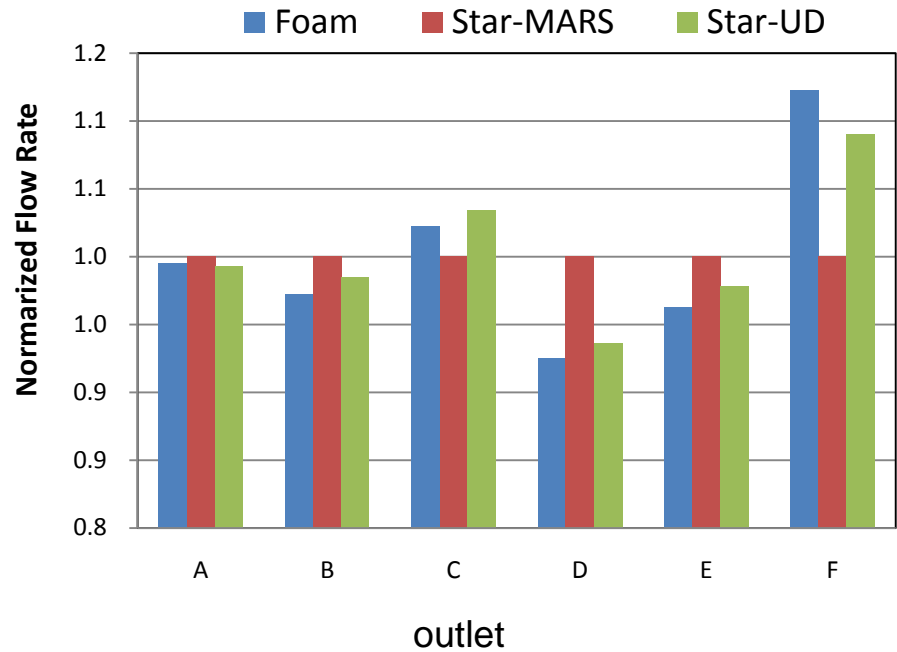

# 事例1 : (3) CAD⇒ICEM⇒FOAM

ICEM Mesh : Tetra w/ Layer

( Partial Zoomed Mesh )

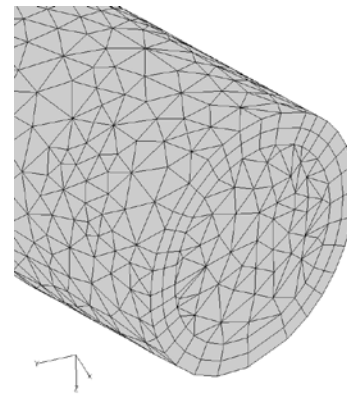
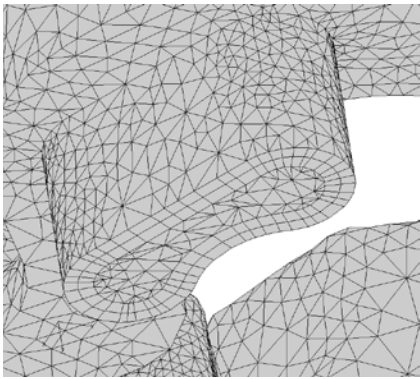

Prostar (V3)で読み込み  
▪ Boundary 設定  
▪ star形式で吐出し  
(.cel,.vrt,.bnd (.cpl) )



Data Conversion  
: [starToFoam \(file\\_root\)](#)

# 事例 1 : (3) CAD⇒ICEM⇒FOAM ⇒Fieldview Diagram (1)

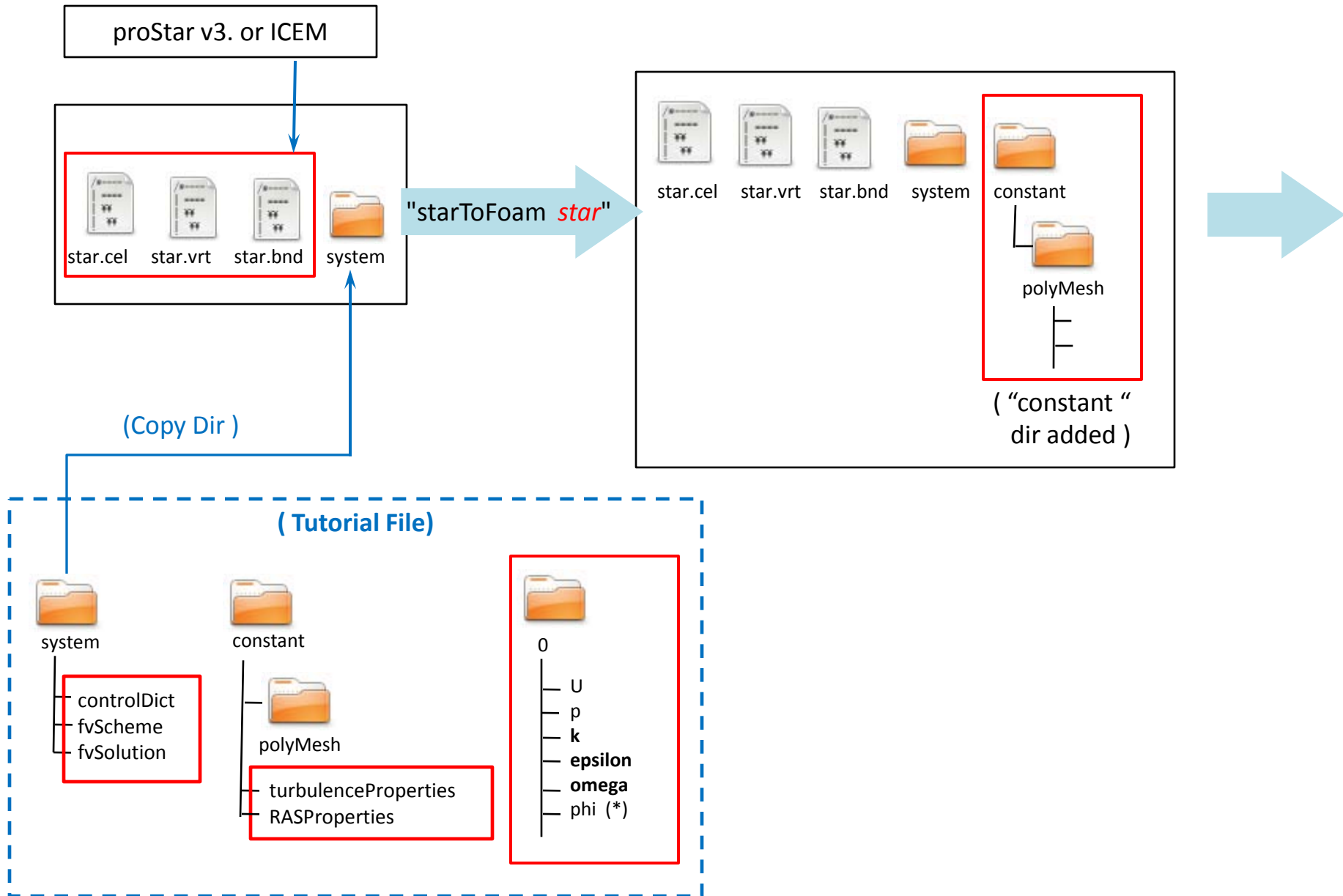

# 事例 1 : (3) CAD⇒ICEM⇒FOAM ⇒Fieldview Diagram (2)

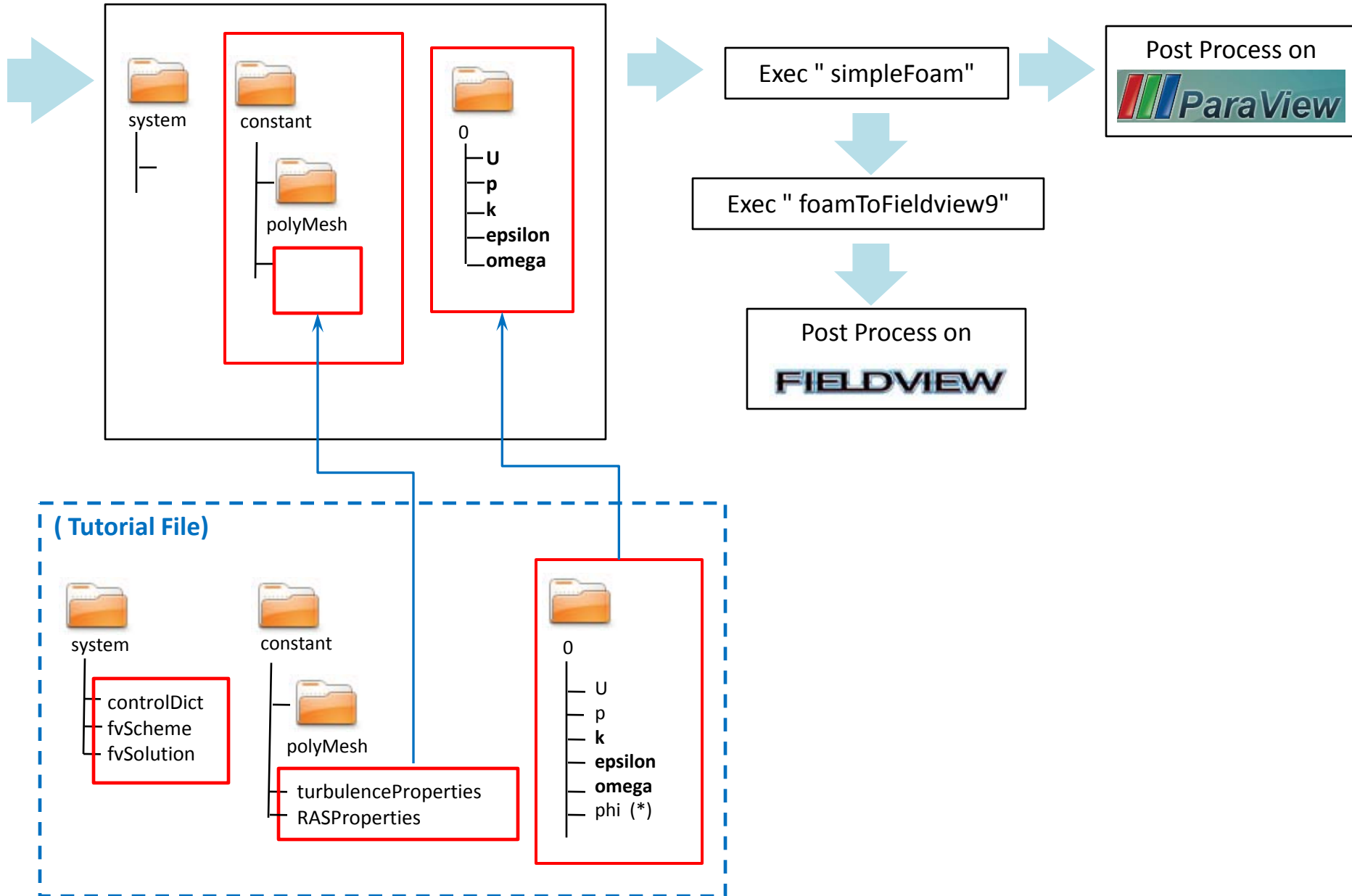

# 事例1: (まとめ) Star to Foam Mesh data conversion

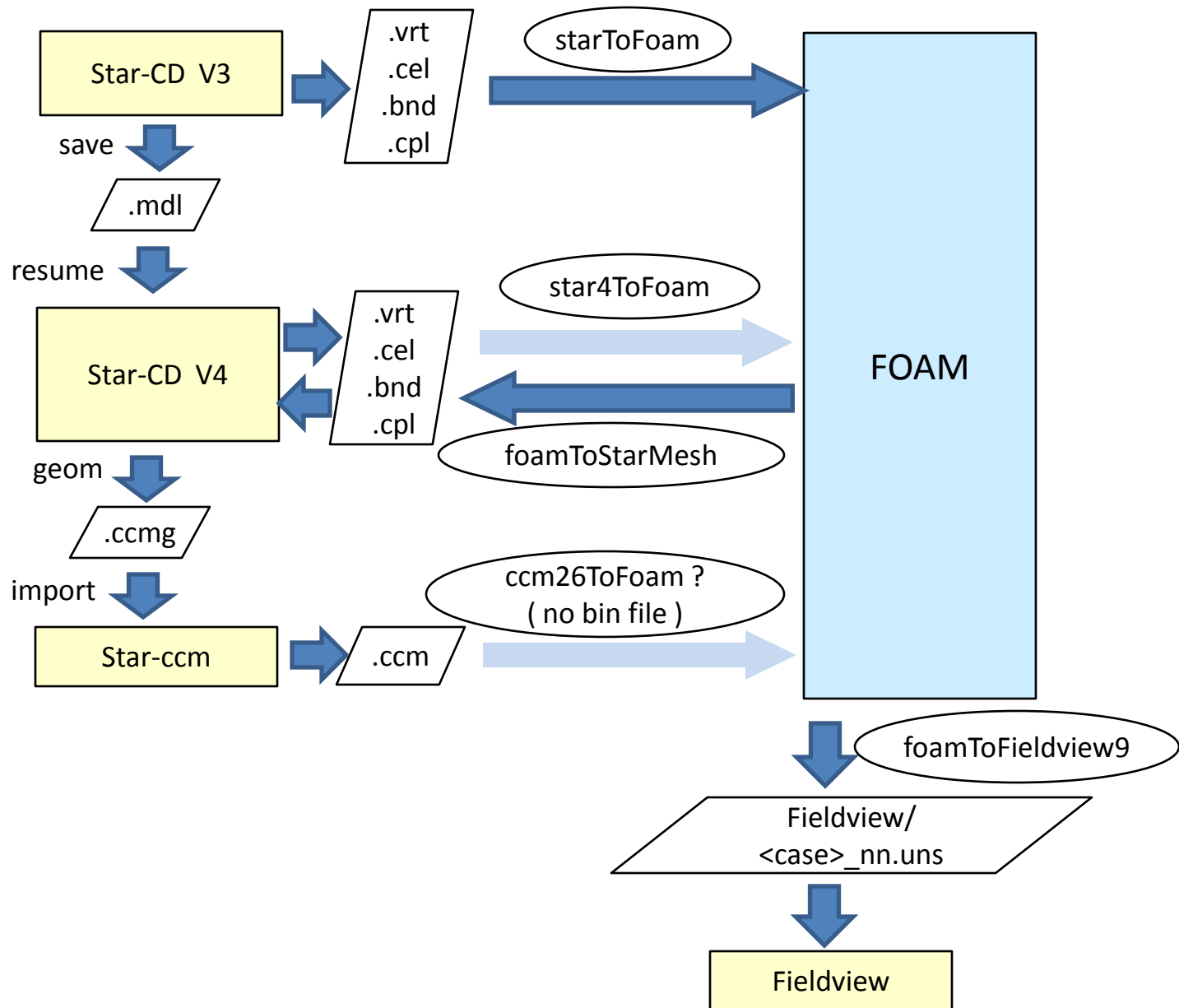

# 事例2: Thermal (buoyantBoussinesqSimpleFoam)

## Mesh and Boundary\* ( Mesh generation on prostar V3)

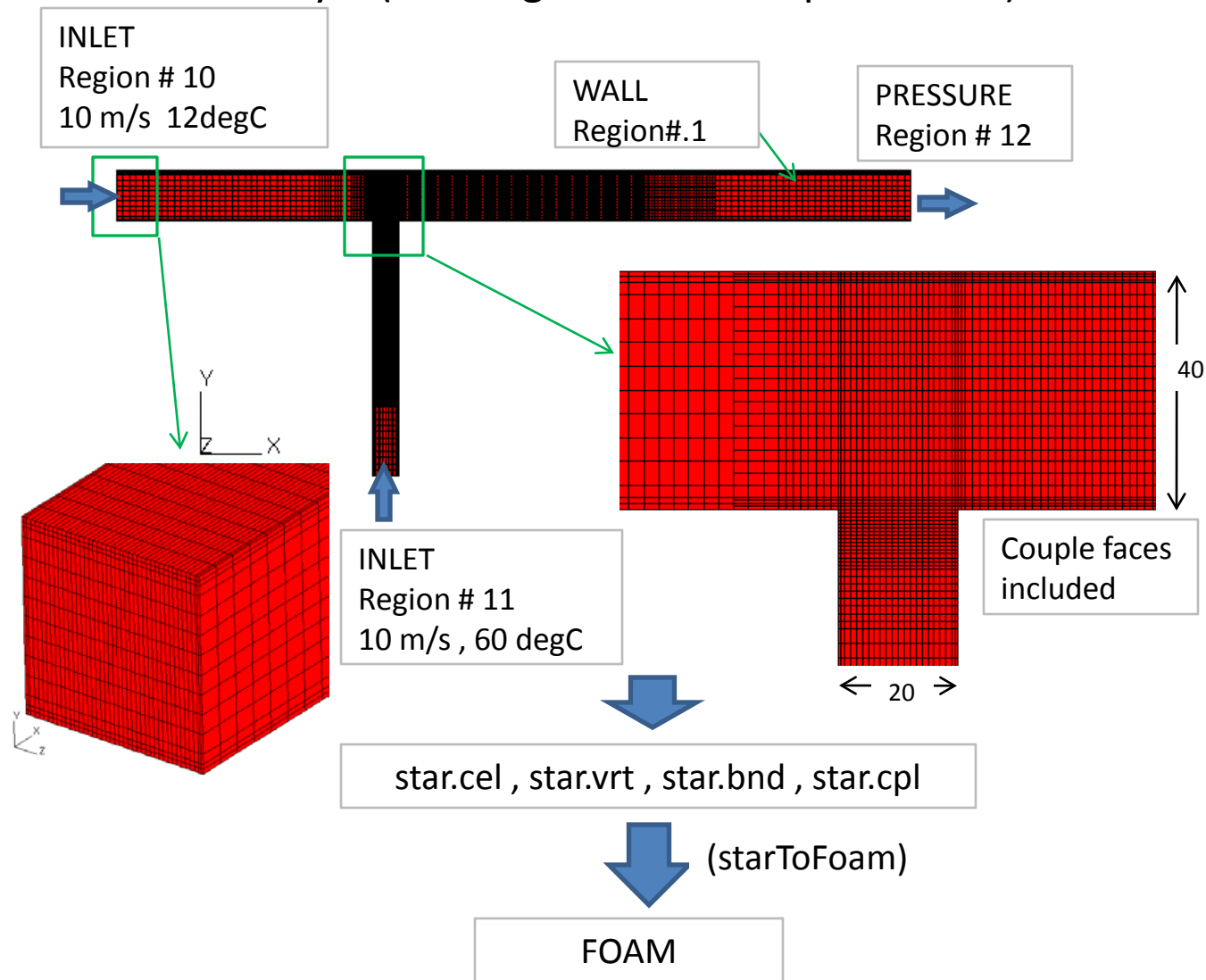

\*:浅野(Denso)ら, 自動車用HVACにおける高・低温空気流の乱流混合に関する研究 (T字形合流管における熱流動特性), 機論B, 71-715 (2005-12)

# 事例2: Thermal (buoyantBoussinesqSimpleFoam)

Relative Temp. Contour at Z = 0

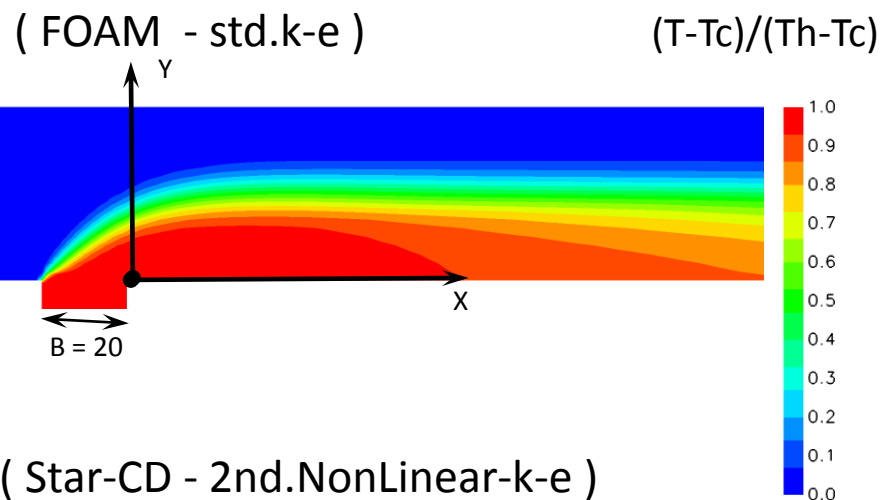

Relative Velo Contour at Z = 0

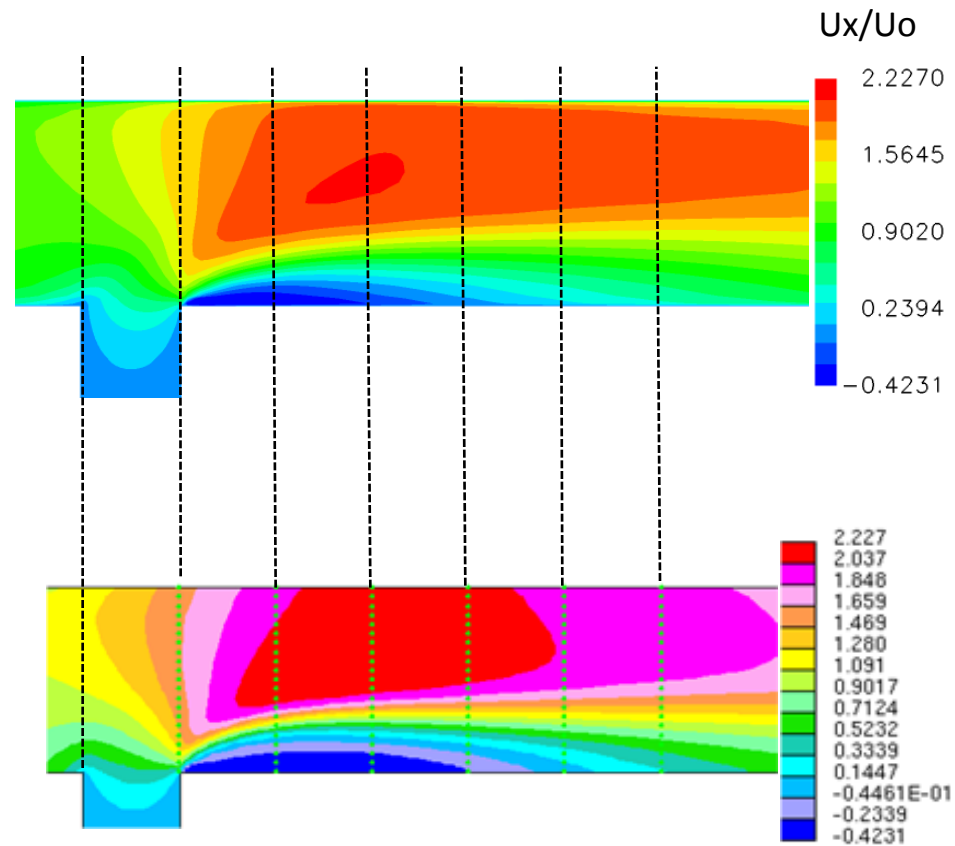

( Star-CD - 2nd.NonLinear-k-e )

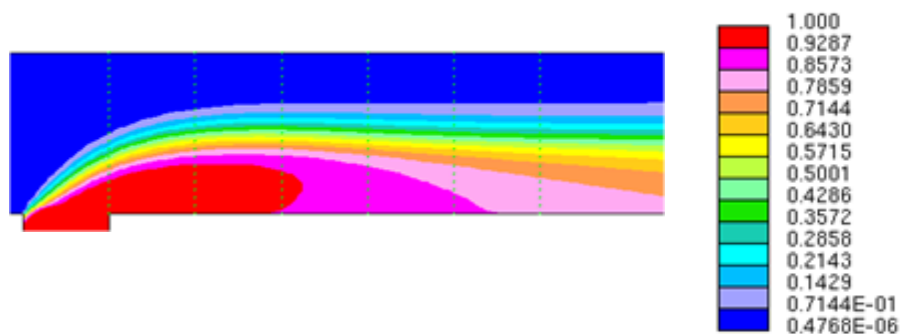

- 温度計算を行え、同一乱流モデルによればStar同等結果が得られたが、安定性悪い。
- 乱流モデル評価／選定

# 事例2: Thermal (buoyantBoussinesqSimpleFoam)

【参考】 Star-CD Results per Turb.Model (Relative Temp. Contour at Z = 0)

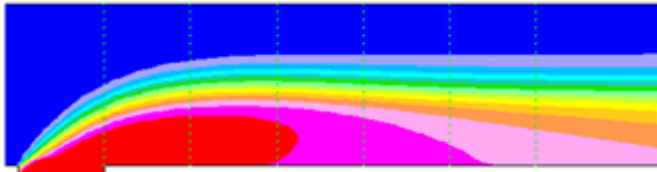

(std.-ke)

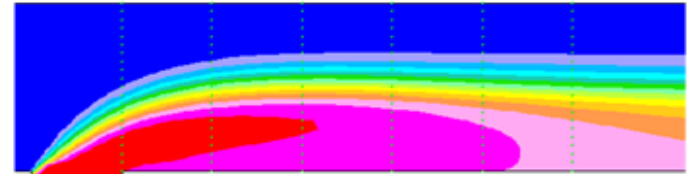

(k $\omega$ -SST)

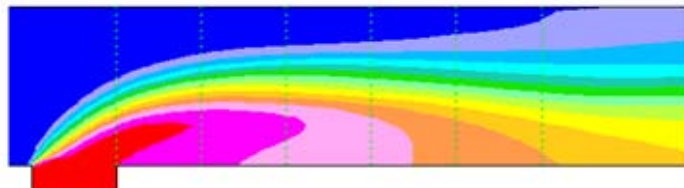

(NonLinear-ke-Quad)

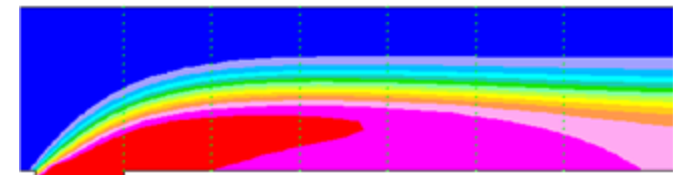

(V2F)

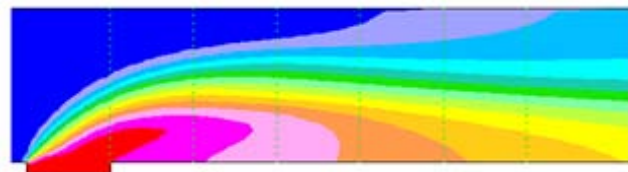

(NonLinear-ke-Cubic)

(T-T<sub>c</sub>)/ $\Delta T$

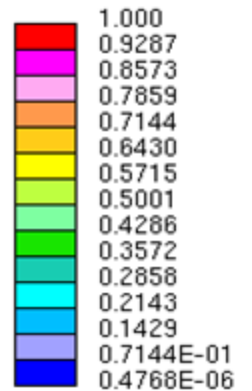

# 事例3 : Porous (rhoPorousSimpleFoam -1.5.x )

../tutorials/rhoPorousSimpleFoam/angleDuctImplicit

## Mesh

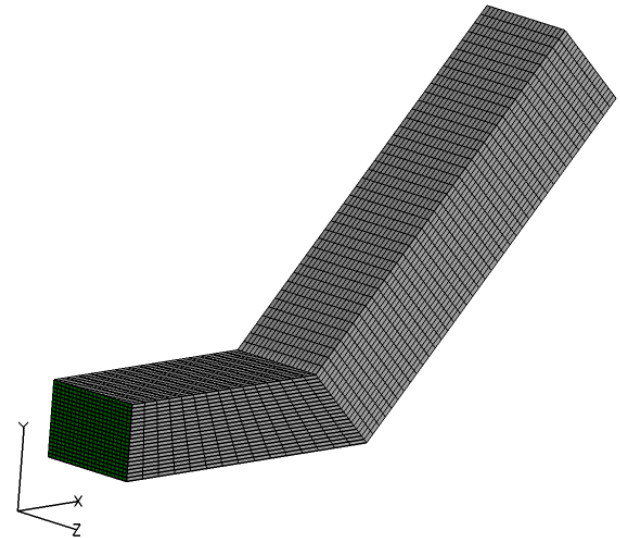
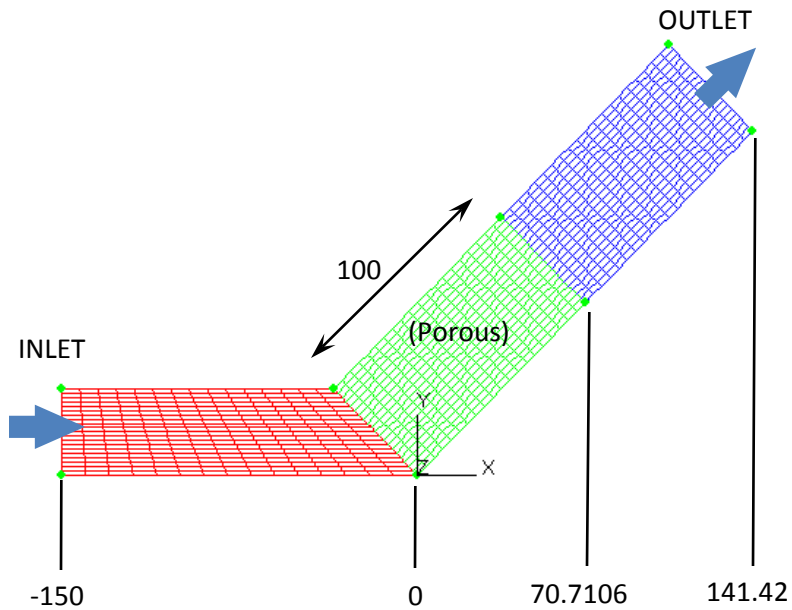

# 事例3 : Porous (rhoPorousSimpleFoam -1.5.x )

## Properties

	FOAM*	Star-CD
	Compressible	InCompressible
Fluid	Air	Air
分子量	28.9	28.96
比熱	1007	1006
融解熱	0	
粘性係数	Sutherland, <b>1.4792e-06 , 116</b>	1.81E-05
密度	Perfect Gas	1.205
TurbModel	std.k-e	Quad.k-e

## B/C

		FOAM	Star-CD
INLET	Velocity	10 m/s	10 m/s
	Temp	293 K	-----
	MixLength	0.001	0.001
	Intensity	0.1	0.1
Wall		Non-Slip	Non-Slip
OUTLET	Pressure	1.0E5 Pa	0

## Scheme

	FOAM	Star-CD
Momentum	Gauss Upwind	MARS
k,e	Gauss Upwind	UD

## Porous

FOAM	Star-CD
DP=150 Pa at 15 m/s , L = 100 mm	
Darcy,	dP=aU <sup>2</sup> +bU (Pa/m)
d = 0 , f = 11.07	a = 6.6667 , b = 0

# 事例3 : Porous (rhoPorousSimpleFoam -1.5.x )

## FOAM (rhoPorousSimpleFOAM )

(Gage Pressure at Z=0)

$$DP = 40.14 - 0.000 = 40.14 \text{ (Pa)}$$

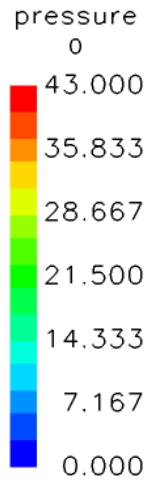

(VMAG at Z=0)

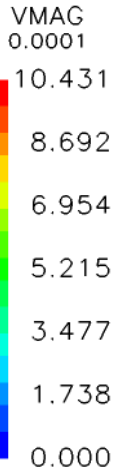

## Star-CD

(Pressure at Z=0)

$$DP = 43.35 - 0.009 = 43.34 \text{ (Pa)}$$

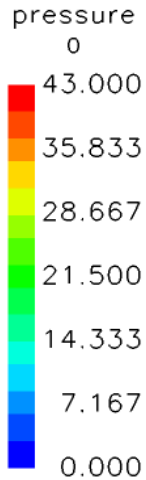

(VMAG at Z=0)

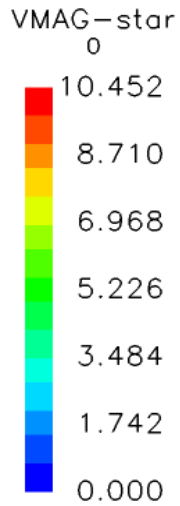

# 事例3 : Porous (rhoPorousSimpleFoam -1.5.x )

- Porousを含む内部流計算を行え、Star同等結果が得られたが、圧縮性ソルバのため設定煩雑。非圧縮ソルバはないか？ (-1.7の/incompressible/porousSimpleFoam/angledDuctExplicit?)
- Porous部位指定方法？ cellZone？

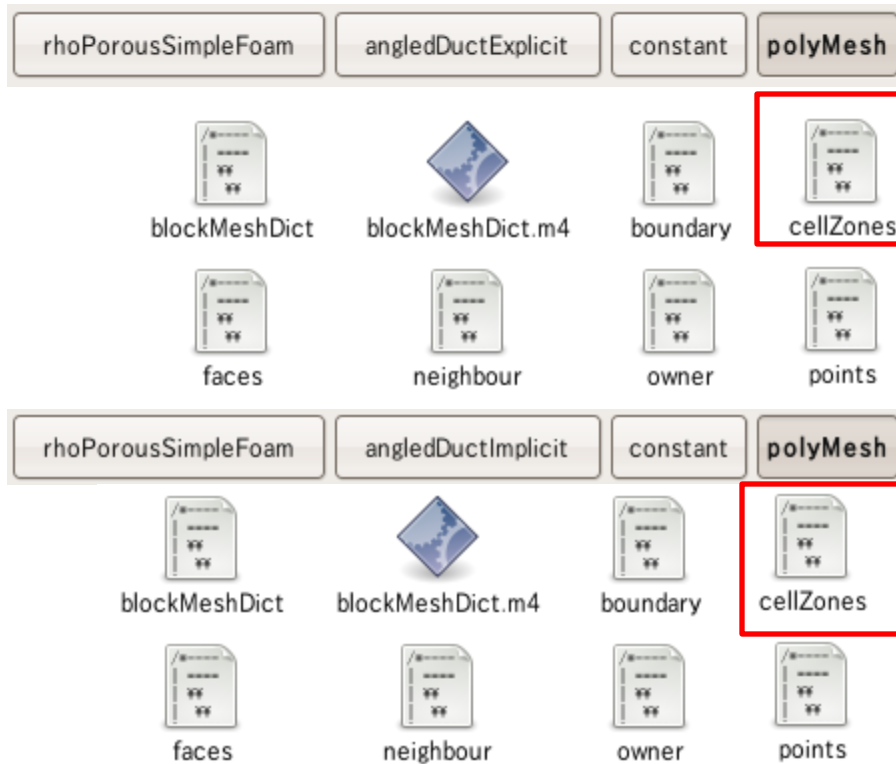

ascii

binary

```
FoamFile
{
    version      2.0;
    format       ascii;
    class        regIOobject;
    location     "constant/polyMesh";
    object       cellZones;
}
// *****

3
(
inlet
{
    type cellZone;
cellLabels    List<label>
6000
(
0
1
2
3
porosity
{
    type cellZone;
cellLabels    List<label>
8000
(
6000
6001
6002
6003
outlet
{
    type cellZone;
cellLabels    List<label>
8000
(
14000
14001
14002
```

- Heat-Source(Sink)の指定方法？

# できるようになったこと/これからやっていくこと

- **CAD データを使用し、simpleFoam で単相流シミュレーションはできる目途が立った。**
  - ⇒ より信頼性,将来性のあるMesh/Boundary data Converter の確保
- **単相流で温度計算を行う 目途も立った。**
  - ⇒ 乱流モデル評価と確定
- **Porousを含む流れシミュレーションのTutorialとその大まかな流れはわかった。**
  - ⇒ Porous位置指定方法の掌握
    - 外部Mesher作成Mesh data からの位置指定方法確保
    - 熱エネルギーSource/Sink との組み合わせ方法

そのほか,

Solid-Fluid 共役熱移動シミュレーション

回転場(MRF/Sliding) , 自由表面/2相流 , FSI ...

GUI